

JBC

www.jbctools.com

INSTRUCTION MANUAL



Nano Rework Station

Ref. NAE-C

Packing List

The following items are included:

Control Unit 1 unit
 Ref. NAE-1C (120V)
 NAE-2C (230V)
 NAE-9C (100V)



Tool Holder 2 units
 Ref. CC2002



Brass Wool 1 unit
 Ref. CL6210



Metal Brush 1 unit
 Ref. CL2466



Allen key 1 unit
 Ref. 009848



Power Cable 1 unit
 Ref. 0023714 (230V)
 0023715 (120V)
 0024092 (100V)



Manual 1 unit
 Ref. 0022995



Features

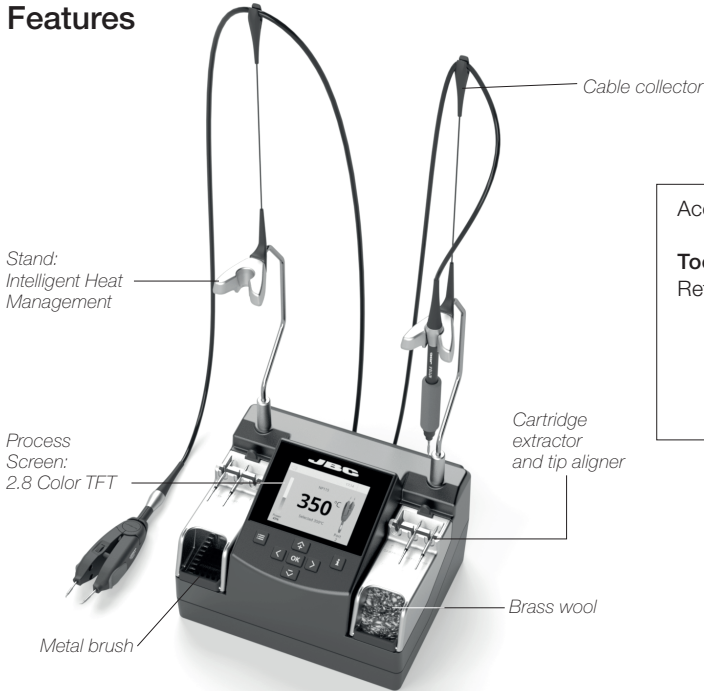

Accessories not included:

Tool extension cord (1m)
Ref. A1205

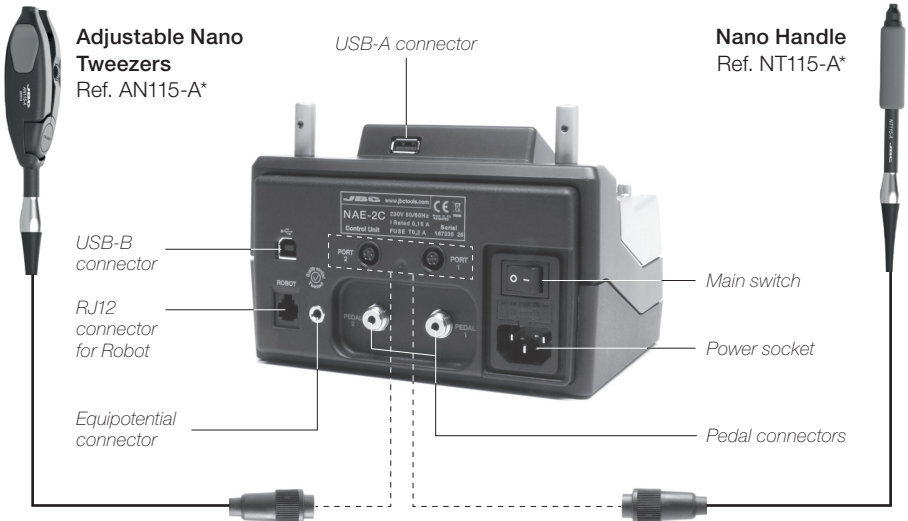

* AN115-A / NT115-A are not included.

Assembly the Tool Holder

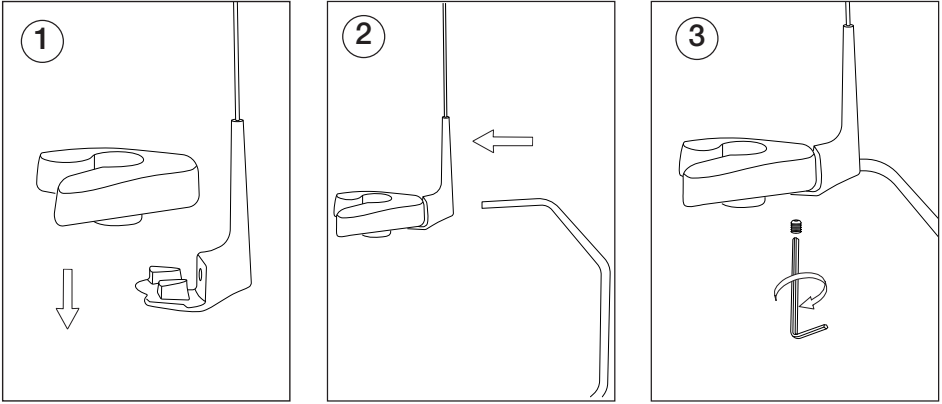

Replacing the Tool Holder

Loosen the screw and withdraw the Tool Holder.

Insert the new Tool Holder and tighten the screw.

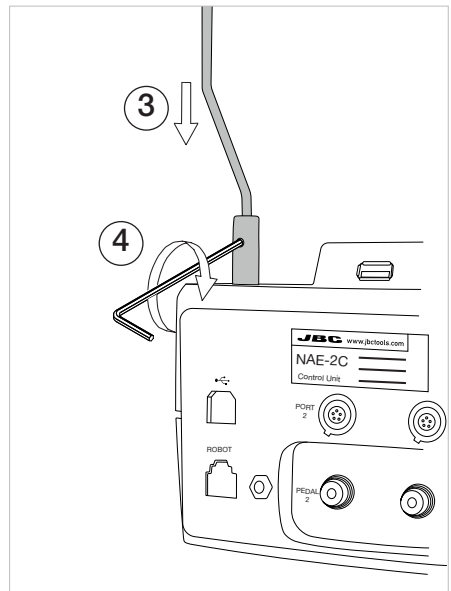
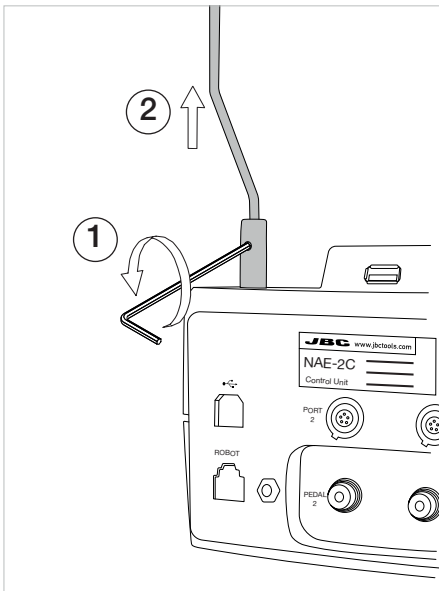

Work Screen

The NAE-C offers an **intuitive user interface** which provides **quick access** to station parameters.
Default PIN: 0105

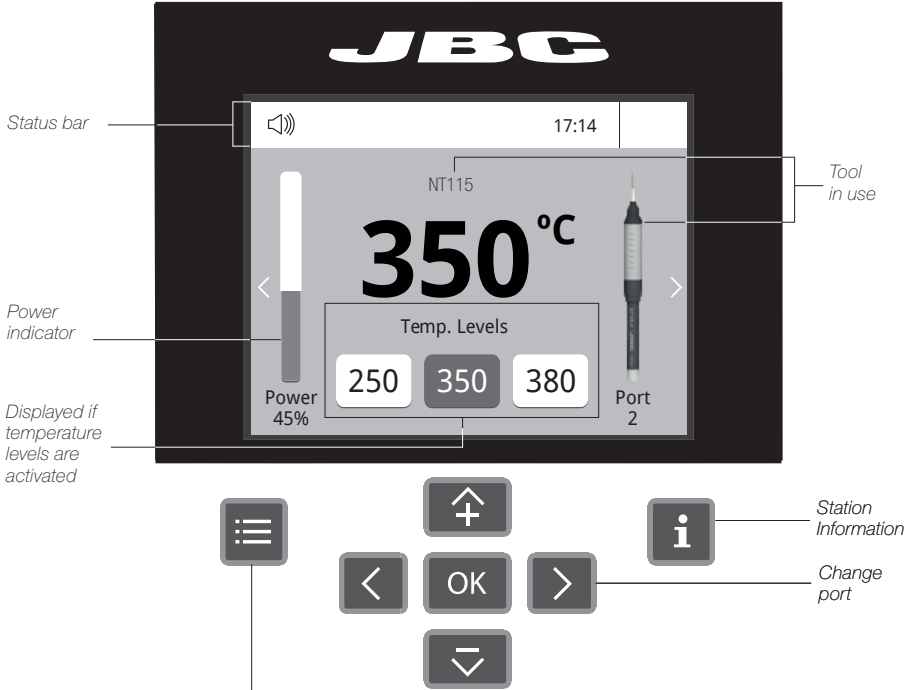

Menu Options



Set the station parameters

Station

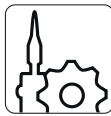

Set the tool parameters

Tools



Display the hours worked in each cycle

Counters



Consult / modify the links of the peripherals connected to the station with the port they are connected to.

Peripherals



It is possible to choose the language from a list.

Language



Allows you to carry out an overall station reset restoring all the parameters to their default values.

Reset

Troubleshooting

Station troubleshooting available on the product page at www.jbctools.com

Advanced functionalities



Graphics

It provides detailed graphics of tip temperature and power delivery in real time during solder joint formation for analysis purposes. This helps you decide how to adjust your process or which tip to use to obtain the best quality soldering.



Profiles

Designed to avoid thermal shock when soldering Ceramic Chip components like MLCC, this new and unique feature allows controlling the heating ramp up rate of the tool to gradually increase the temperature of the component through all the phases of the soldering process. Up to 25 fully configurable soldering profiles can be stored.

JBC Net

The first system to optimize traceability in soldering

- Get greater quality and control in your production
- Manage your whole soldering process remotely in real time



Files

Export graphics

Insert a USB flash drive into the USB-A connector to save your soldering process in csv format.



Update

Station update

Download the JBC Update File from www.jbctools.com/software.html
Insert the USB flash drive with the file downloaded to the station.

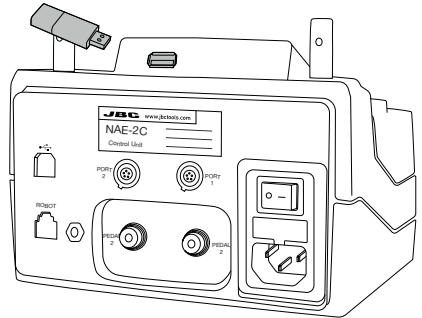

System notifications

The following icons will be displayed on the screen's status bar.



USB flash drive is connected.



Station is controlled by a PC.



Station is controlled by a robot.



Station software update.
Press INFO to start the process.



Warning.
Press INFO for failure description.



Error.
Press INFO for failure description,
the type of error and how to proceed.

Operation

The JBC Exclusive Heating System

Our revolutionary technology is able to recover tip temperature extremely quickly. It means the user can work at a lower temperature and improve the quality of soldering. The tip temperature is further reduced thanks to the Sleep and Hibernation modes which increase the tip life by 5.

1. Work

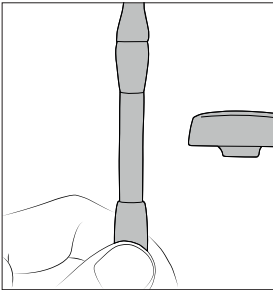

When the tool is lifted from the holder the tip will heat up to the selected temperature.

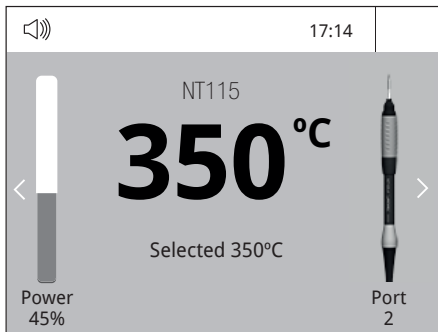

Tools Menu:

- Set temperature limits
- Set temperature levels

2. Hibernation

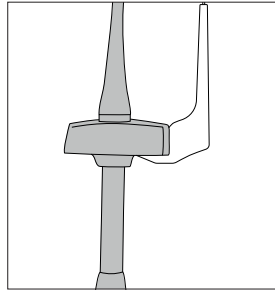

When the tool is in the holder, the power is cut off and the tool cools down to room temperature.

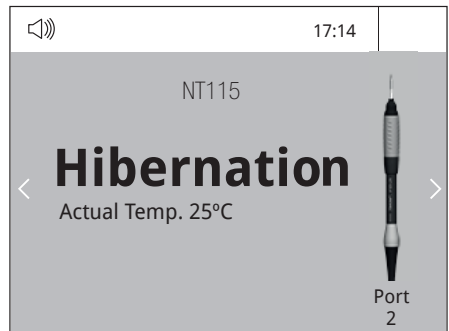

Tools Menu:

- Set Hibernation delay (from 0 to 60 min or no Hibernation)

Chip Components Rework proces using Tweezers and pedal

The Adjustable Nano Tweezers is the most effective tool for desoldering chip components but also it facilitates its rapid placement and soldering by using the P-405 pedal connected to the station.

1

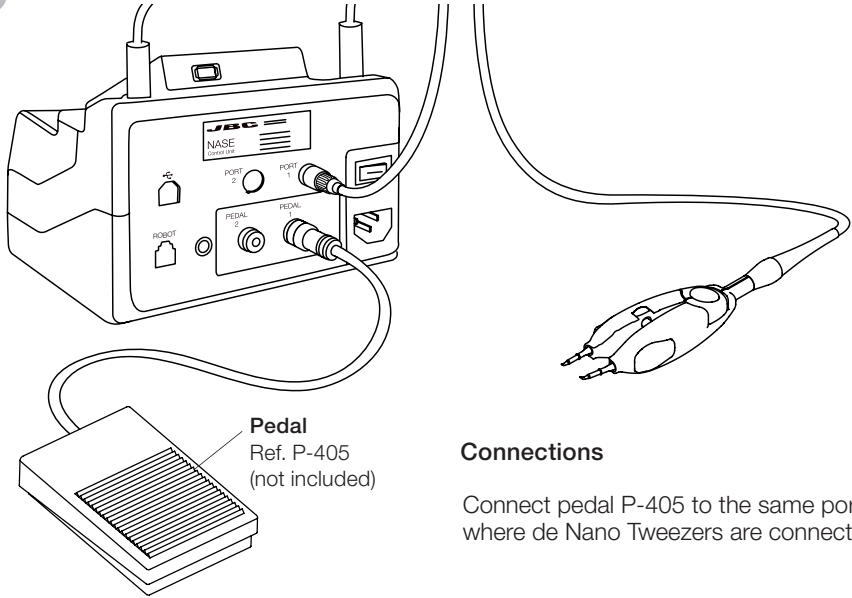

Connections

Connect pedal P-405 to the same port where de Nano Tweezers are connected.

2

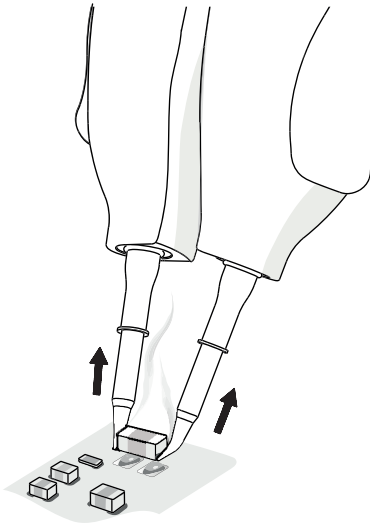

Desoldering

Lift the tool from the holder and desolder the component.

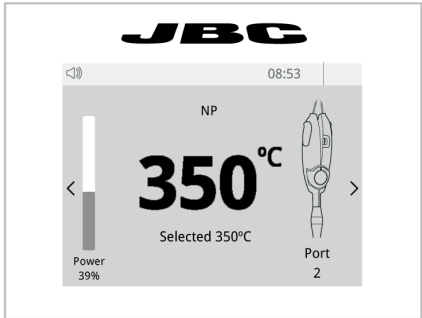

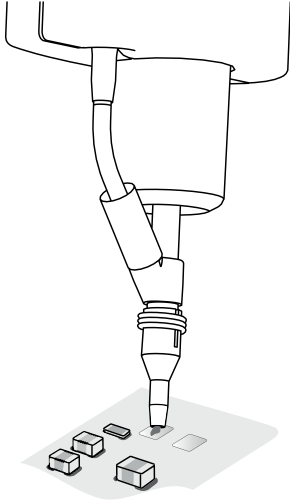
3**Pad cleaning**

Clean the pads with the desoldering tool DS360-A*.

* Secondary station is needed.

4**Solder paste dispensing**

Apply the solder paste amount needed to solder the new chip component.

5

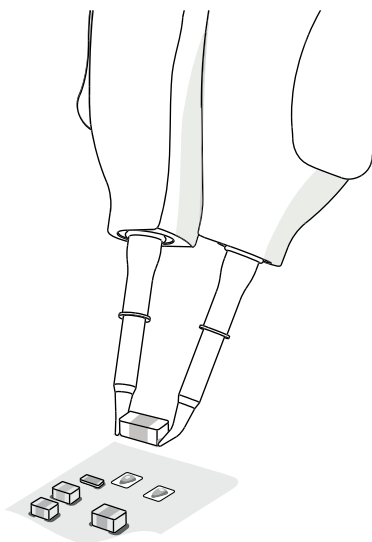

Placing

Press and hold the pedal and use the tool to position the component on the previously tinned pads.

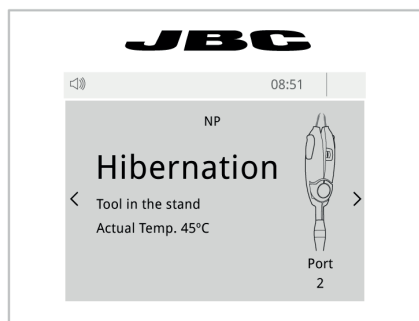

6

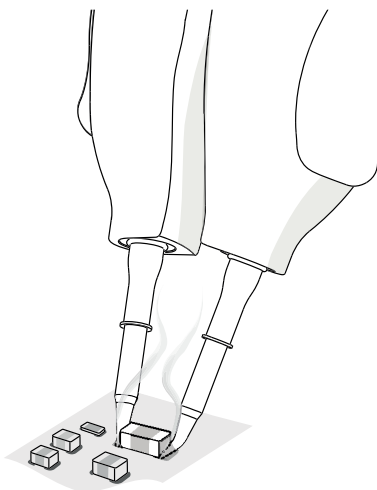

Soldering

Once in position, press and hold the pedal to perform the soldering.

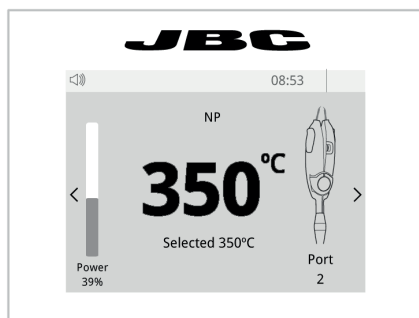

Changing cartridges

Save time and change cartridges safely without having to switch the station off.

Removing

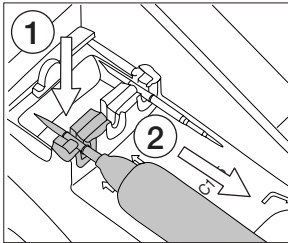

Place the cartridge in the slot as shown and pull the handle to remove it.

Inserting

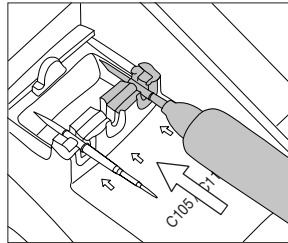

Push the cartridge into the handle to the mark*.

Aligning

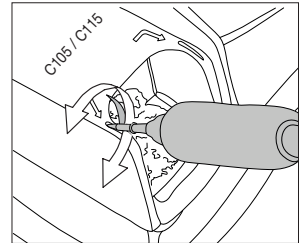

Use the holes to rotate the cartridges for a proper alignment.

*Important

It is essential to insert the cartridges as far as the reference for a proper connection.

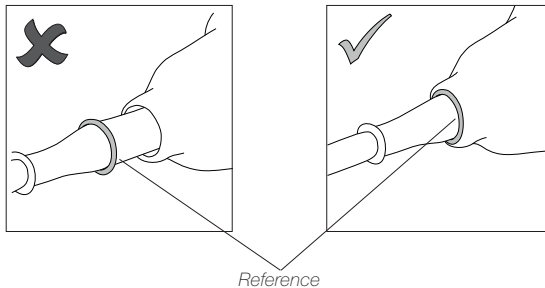

Compatible cartridges

The **NT115-A** and **AN115-A** work with **C115** cartridges. Find the model that best suits your soldering needs on www.jbctools.com



Conical



Chisel



Bevel



Conical bent

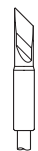

Knife



Stainless steel chisel



High thermal performance

Changing grips

1. Push the grip with the tabs onto the handle.

Grip for NT115-A

Nano handle

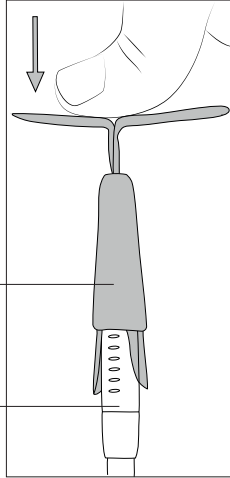

2. To remove the tabs, hold the grip and pull them out. Use a pliers if necessary.

Tabs

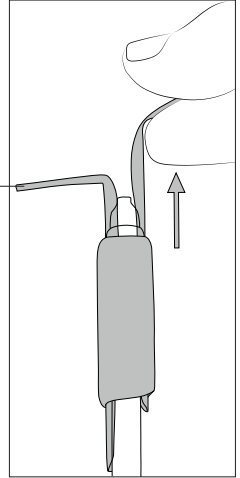

Changing the tip cleaning system

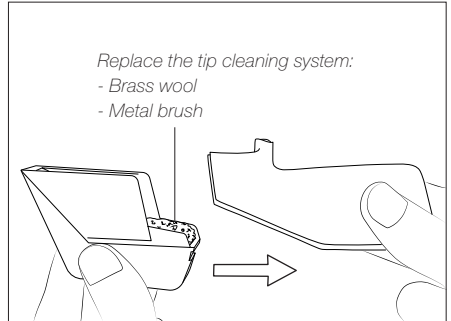
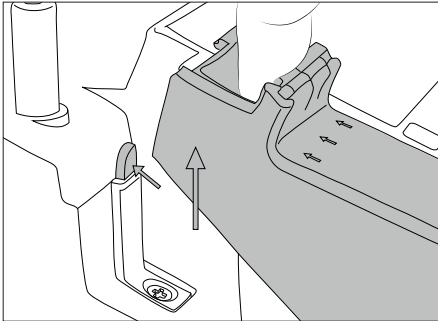

Maintenance

Before carrying out maintenance or storage, always allow the equipment to cool.

- Clean the station screen with a glass cleaner or a damp cloth.
- Use a damp cloth to clean the casing and the tool. Alcohol can only be used to clean the metal parts.
- Periodically check that the metal parts of the tool and stand are clean so that the station can detect the tool status.
- Maintain tip surface clean and tinned prior to storage in order to avoid tip oxidation. Rusty and dirty surfaces reduce heat transfer to the solder joint.
- Periodically check all cables and tubes.
- Replace a blown fuse as follows:

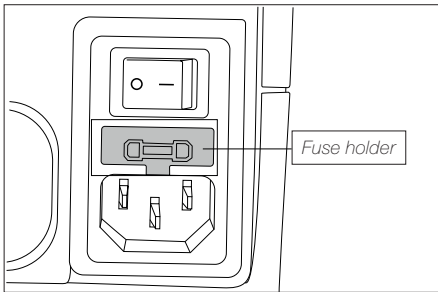

1. Pull off the fuse holder and remove the fuse. If necessary use a tool to lever it off.

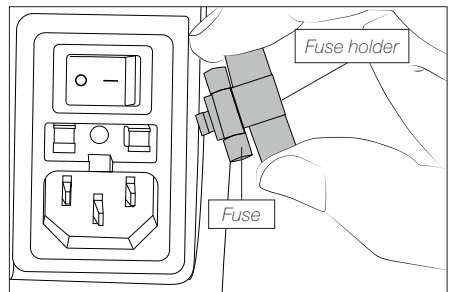

2. Press the new fuse into the fuse holder and replace it in the station.

- Replace any defective or damaged pieces. Use original JBC spare parts only.
- Repairs should only be performed by a JBC authorized technical service.

Safety



It is imperative to follow safety guidelines to prevent electric shock, injury, fire or explosion.

- Do not use the units for any purpose other than soldering or rework. Incorrect use may cause fire.
- The power cord must be plugged into approved bases. Be sure that it is properly grounded before use. When unplugging it, hold the plug, not the wire.
- Do not work on electrically live parts.
- The tool should be placed in the stand when not in use in order to activate the sleep mode. The soldering tip, the metal part of the tool and the stand may still be hot even when the station is turned off. Handle with care.
- Do not leave the appliance unattended when it is on.
- Do not cover the ventilation grills. Heat can cause inflammable products to ignite.
- Avoid the contact of flux with skin or eyes to prevent irritation.
- Be careful with the fumes produced when soldering.
- Keep your workplace clean and tidy. Wear appropriate protective glasses and gloves when working to avoid personal harm.
- Utmost care must be taken with liquid tin waste which can cause burns.
- This appliance can be used by children over the age of eight and also persons with reduced physical, sensory or mental capabilities or lack of experience provided that they have been given adequate supervision or instruction concerning use of the appliance and understand the hazards involved. Children must not play with the appliance.
- Maintenance must not be carried out by children unless supervised.

有害物质含量表

产品中有害物质的名称及含量

部件名称	有害物质					
	铅(Pb)	汞(Hg)	镉(Cd)	六价铬 (Cr(VI))	多溴联苯 (PBB)	多溴二苯醚 (PBDE)
烙铁头	○	○	○	○	○	○
手柄	○	○	○	○	○	○
电源线	○	○	○	○	○	○
主机	○	○	○	○	○	○
电源插座	○	○	○	○	○	○
保险丝	○	○	○	○	○	○
主开关	○	○	○	○	○	○
电位连接	X	○	○	○	○	○
变压器	○	○	○	○	○	○
线路板	X	○	○	○	○	○

○ 表示该有害物质在该部件所有均质材料中的含量均在GB/T 26572 规定的限量要求以下。
X 表示该有害物质至少在该部件的某一均质材料中的含量超出GB/T 26572 规定的限量要求。

Specifications

NAE-1C 120V 50/60Hz. Input fuse: 0.5A. Output: 8.5V
NAE-2C 230V 50/60Hz. Input fuse: 0.2A. Output: 8.5V
NAE-9C 100V 50/60Hz. Input fuse: 0.5A. Output: 8.5V

- Output Peak Power: 14W per tool
- Temperature Range: 90 - 450 °C (190 - 840 °F)
- Idle Temp. Stability (still air): $\pm 1.5^{\circ}\text{C}$ ($\pm 3^{\circ}\text{F}$) / Meets and exceed IPC J-STD-001
- Temp accuracy: $\pm 3\%$ (using reference cartridge)
- Temp adjustment: $\pm 50^{\circ}\text{C}$ ($\pm 90^{\circ}\text{F}$) Through station menu setting
- Tip to ground voltage: Meets and exceed
- Tip to ground resistance: ANSI/ESD S20.20-2014 IPC J-STD-001F
- Ambient operating temp: 10 - 50 °C (50 - 122 °F)
- Connections: USB-A / USB-B / Pedal connectors
RJ12 connector for Robot
- Control Unit Weight: 2,5 kg (5.40 lb)
- Control Unit Dimensions: 170 x 90 x 135 mm (6.70 x 3.54 x 5.31 in)

Complies with CE standards
ESD Safe

JBC

Warranty

JBC's 2 year warranty covers this equipment against all manufacturing defects, including the replacement of defective parts and labour.

Warranty does not cover product wear or misuse.

In order for the warranty to be valid, equipment must be returned, postage paid, to the dealer where it was purchased.

Get 1 extra year JBC warranty by registering here:
<https://www.jbctools.com/productregistration/>
within 30 days of purchase.



This product should not be thrown in the garbage.

In accordance with the European directive 2012/19/EU, electronic equipment at the end of its life must be collected and returned to an authorized recycling facility.

